

SMART WAY TO HANDLE THE AIR

# AmberAir

Compact CXP



# SALDA

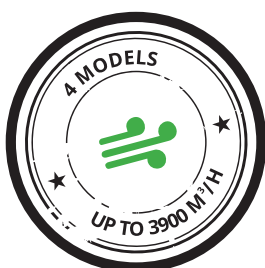
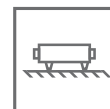
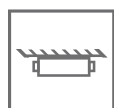

# AmberAir Compact CXP SERIES

SMART WAY TO HANDLE THE AIR



The AmberAir Compact CXP is a new generation of ceiling air handling units with an advanced casing and unique maintenance solution, which allows the installation of a unit indoors or outdoors (with optional roofing) and under the ceiling or on the ground. The extended airflow range (up to 3900 m<sup>3</sup>/h) enables them to substitute for traditional horizontal and vertical units in order to save space on the ground for other equipment.

**AmberAir Compact CXP IS AN IDEAL AIR HANDLING SOLUTION FOR RECONSTRUCTION OR NEW BUILDING PROJECTS SUCH AS:**



Schools



Offices



Retail stores



Hotels



Industry

## DELIVERY IN 2 WEEKS

Our newly implemented production system allows minimizing the time period for the production of air handling units. We guarantee a 2 week manufacturing period for all AmberAir Compact series!

## KEY FEATURES

- › Installation options: ceiling or ground, indoors or outdoors;
- › Easy filter changes from the side without opening doors;
- › Optional components: two sizes of integrated water or electrical heaters, with various class pocket or panel filters and left/right service sizes;
- › Tested at independent laboratories: a climatic performance test for temperatures ranging from -35° C to +40° C;
- › High efficiency: up to 90% heat recovery, new generation EC fans, smart control, and a 0-10V modulating controlled integrated electrical heater;
- › Demand control level with an integrated humidity sensor;
- › Certified by Eurovent Certita Certification.

# THIN AND EFFICIENT

The AmberAir Compact has the lowest height among other comparable air handling units on the market. Even the biggest size 4 is lower than an ordinary coffee table.

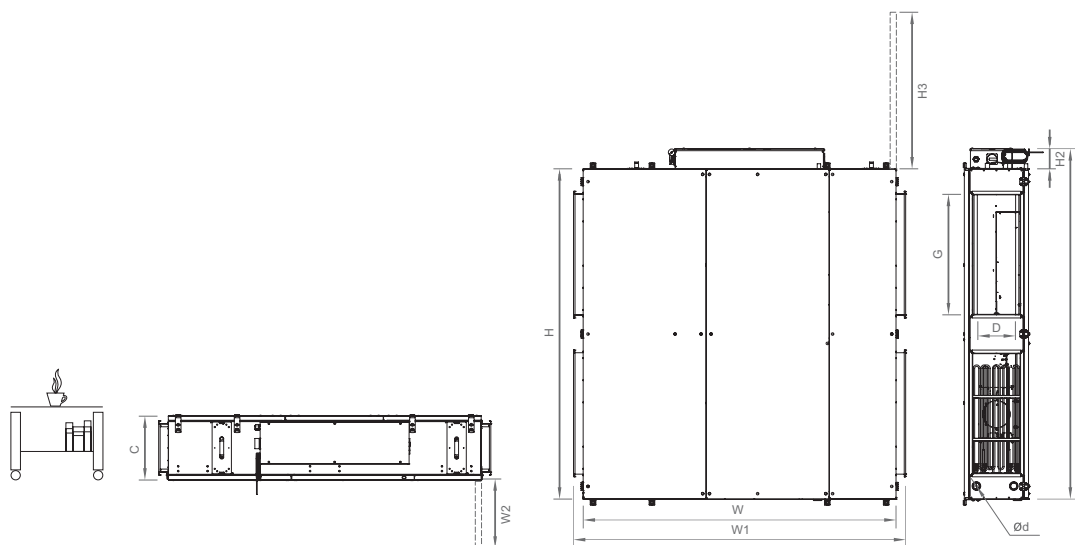

	W	W1	W2	C	H	H1	H2	H3	G	D	ød	ø cond.	Weight kg
1-CXP	1750	1852	875	385	1397	1534	137	650	500	250	46	21,3	169
2-CXP	1850	2020	725	400	1850	1975	125	900	700	300	46	21,3	179
3-CXP	1950	2070	770	400	2060	2185	125	1010	750	300	46	21,3	301
4-CXP	2250	2370	880	500	2250	2370	120	1120	750	350	46	21,3	361

## AmberAir Compact CXP AIRFLOWS AND SIZES

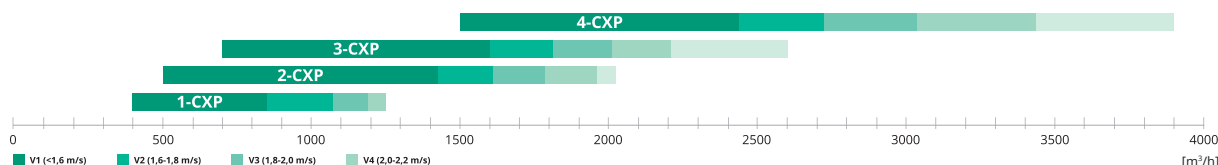

## 5 EFFICIENCY BONUSES FOR YOUR PROJECT

The AmberAir Compact CXP provides top energy savings in its class:



Up to 90%  
heat recovery



Efficient  
EC fans



External  
leakage <math><2\%</math>



Demand control ready ventilation with an  
integrated extract air humidity sensor\*



Modulating control  
el. heater

\* Other comfort sensors ( $\text{CO}_2$ , presence) are available as accessories.

# FLEXIBLE AmberAir Compact CX P DESIGN



<p><b>1. Counter-flow aluminium heat exchanger:</b></p> <ul style="list-style-type: none"> <li>&gt; Efficiency up to 90%;</li> <li>&gt; Separated supply and exhaust air: almost no moisture transfer, no mixing;</li> <li>&gt; Low maintenance;</li> <li>&gt; Stainless steel drip tray – high draining efficiency 95%.</li> </ul>	<p><b>2. Integrated advanced MCB control board:</b></p> <ul style="list-style-type: none"> <li>&gt; Demand control ready ventilation;</li> <li>&gt; Control by remote controllers, PC via MB-Gateway or BMS (ModBus);</li> <li>&gt; Fire damper control and testing;</li> <li>&gt; El. heater/preheater 0-10V control;</li> <li>&gt; Water heater/preheater control and protection;</li> <li>&gt; DX/water cooler, air dampers control;</li> <li>&gt; Constant airflow mode.</li> </ul>
<p><b>3. Pressure relay – additional anti-frost protection for heat exchanger.</b></p>	<p><b>4. Double-skinned casing panels:</b></p> <ul style="list-style-type: none"> <li>&gt; 50/30 mm of mineral wool insulation*;</li> <li>&gt; Galvanized steel powder coated corrosion class – C3.</li> </ul>
<p><b>5. Panel or pocket filters:</b></p> <ul style="list-style-type: none"> <li>&gt; Class F7, M5 or G4;</li> <li>&gt; Fully recyclable;</li> <li>&gt; Supply/extract filter pressure switch.</li> </ul>	<p><b>6. 100% motorized by-pass damper.</b></p>
<p><b>7. DTJ – humidity - temperature sensor.</b></p>	<p><b>8. EC fans with a backwards curved impeller.</b></p>
<p><b>9. Heater:</b></p> <ul style="list-style-type: none"> <li>&gt; Integrated modulating control electric heater (signal 0-10V);</li> <li>&gt; Integrated water heater.</li> </ul>	



## EXTREMELY SERVICE FRIENDLY

- > Its unique construction enables fast and flexible service without complex tooling;
- > Easy filter change with 3 variants: side, top or bottom;
- > Maintenance sides: top for ground installment or bottom for ceiling installment;
- > Bottom cover opening options: rails\*\* or hinged doors.

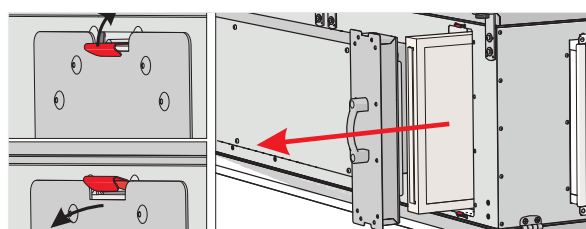

\* - 50 mm casing, 30 mm doors; available 50 mm door insulation option.

\*\* - optional.

## AIR PERFORMANCE\*

### Compact 1-CXP

— Performance  
 - - Power consumption

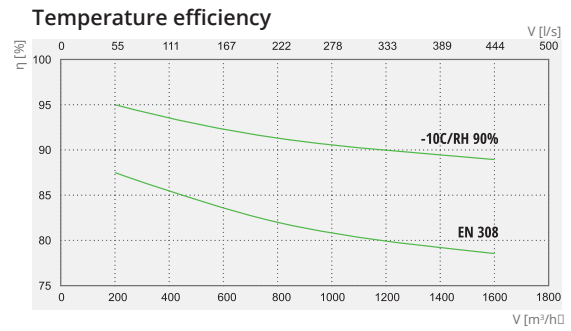
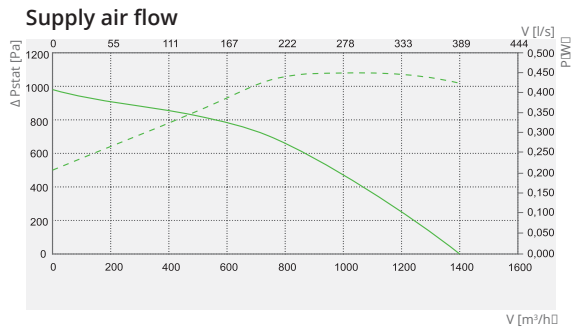

## AIR PERFORMANCE\*

### Compact 2-CXP

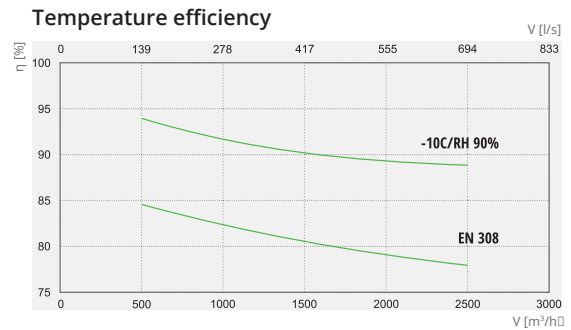
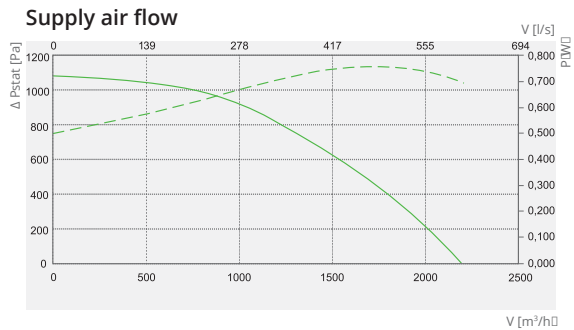

## AIR PERFORMANCE\*

### Compact 3-CXP

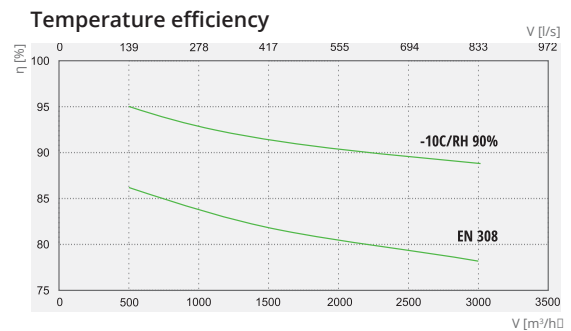
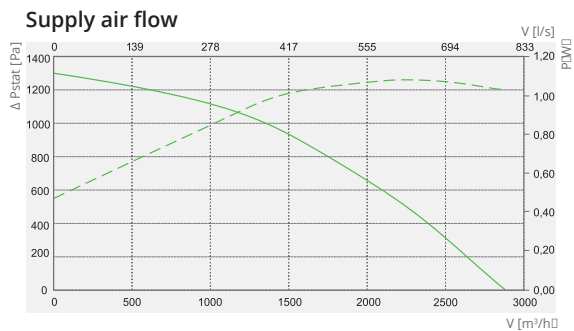

## AIR PERFORMANCE\*

### Compact 4-CXP

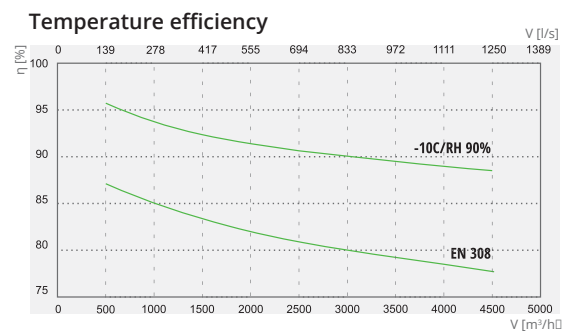
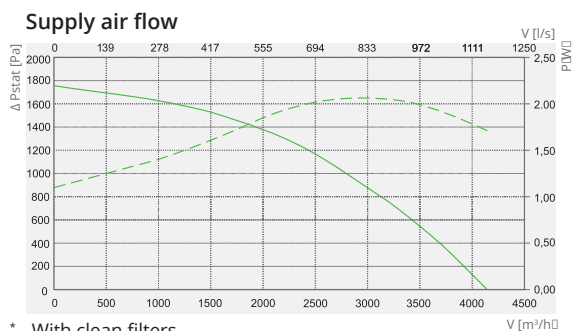

\* - With clean filters.

# CONNECTION DIAGRAM

Version with an integrated electrical heater:

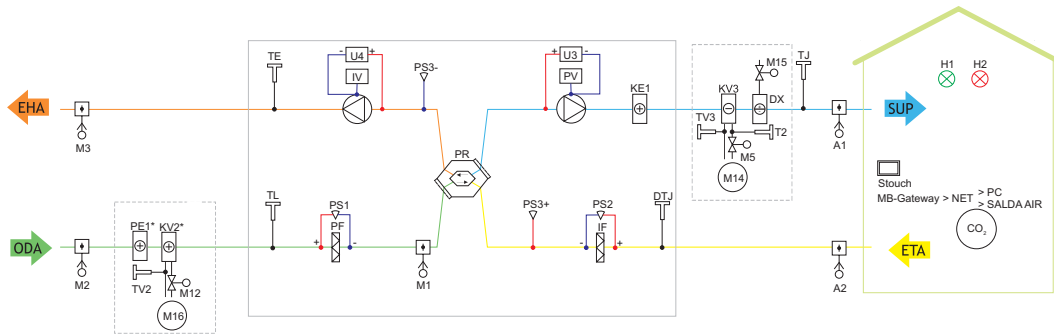

Version with an integrated water heater:

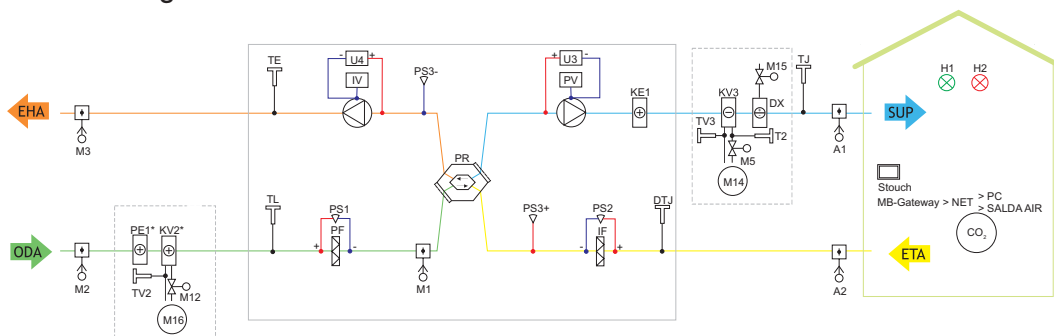

## List of Components

□	Plate heat exchanger	M15	DX cooler valve actuator
PV	Supply air fan	M16	Water preheater circulation pump
IF	Extract air filter	A1	Fire alarm damper actuator I
PF	Supply air filter	□□	Fire alarm damper actuator II
IV	Exhaust fan	TJ	Supply air temperature sensor
KE1	Electric heater	TL	□ outdoor air temperature sensor
PE1*	Electric pre-heater	TE	Exhaust air temperature sensor
KV1	Water heater (reverse mode available)	DTJ	Extract air temperature and ΔH sensor
KV2*	Water pre-heater	TV1	Water heater temperature sensor
KV3	Water cooler	TV2	Water pre-heater temperature sensor
DX	DX cooler	TV3	Water cooler temperature sensor
M1	□ actuator for by-pass damper	T1	Water heater thermostat
M□	□ actuator for supply air damper	T□	Cooler switching thermostat
M3	□ actuator for exhaust air damper	PS1	Supply air filter pressure switch (□□)
M4	Water heater circulation pump	PS□	Extract air filter pressure switch (□□)
M5	Water cooler valve motor	PS3	Heat converter pressure switch (□C)
M□	Water heater valve motor	U3	Supply air fan pressure sensor
M12	Water preheater valve motor	□4	Extract air fan pressure sensor
M14	Water cooler circulation pump**		

## List of external sensors, inputs/outputs and controllers

□□	□□ sensor	F□	Fire alarm
Stouch	□ remote control panel	FPP	Fireplace protection
□□LD□ □□	Mobile application		System mode switch (start/stop)
MB-Gateway	□ network module		Fans speed switch (B□ □ ST)
□ ET	□ network	H1	□ peration indication output
PC	Computer	H□	□ alarm indication output

## Symbols

	□ outdoor air		Extract air		Exhaust air		Supply air		Ventilated premises
--	---------------	--	-------------	--	-------------	--	------------	--	---------------------

\* - only one preheater can be connected.  
 \*\* - only one cooler can be connected.

# ADVANCED CONTROL FUNCTIONS

Descriptions of the functions	Descriptions of the functions
System modes	• Indication of outputs (Working indication, alarm indication) •
Weekly Schedule	• BMS connection •
Holiday Schedule	• Outdoor/Exhaust air dampers control •
BMS ST function	• Fans protection •
Protection against Dryness	• Outdoor temperature sensors (outdoor, supply, extract, exhaust) •
Light cooling	• Water heater temperature sensor •
Air Flow Adjustment	• Electrical heater/preheater On/Off or 0-10V control •
System Monitoring	• Water heater/preheater control and frost protection •
Supply Air Temperature Control and Compensation	• Water cooler control ○
System Mode Communication with an External Contactor	○ Water cooler reverse •
Fireplace function	• Filter Protection by switch and timer •
Fireplace protection (°C)	○ Fire Dampers control and testing •
CO <sub>2</sub> reduction	○ DX cooler control and reverse •
Relative humidity reduction	• Recirculation •
Fan control by pressure	• By-pass damper control •
Fire Protection from an External Contactor	• Control panel Stouch •
Heat Exchanger Frost Protection	• Network module MB-Gateway with web-based control software •
Digital Input Configuration	•

○ - Requires additional components such as CO<sub>2</sub> sensors, etc.

• - Standard functions (Quantity of functions depends on the model), managed by BMS or remote controllers.

• - Remote controllers.

## TECHNICAL DATA

### ELECTRICAL DATA

AmberAir Compact	Max. electric power input of fans, kW	Phase/voltage/frequency of fan, f/VAC/Hz	Electric power input of electrical heater, kW		Phase/voltage/frequency of electrical heater, f/VAC/Hz		Max. power consumption		
			E1	E2	E1	E2	F1 E1	F1 E2	F1 W1/2
1-CXP	0,76	1~/230/50	2,0	3,6	1~/230/50	1~/230/50	2,76	4,36	1,06
□-CXP	0,78	1~/230/50	3,0	6,0	3~/400/50	3~/400/50	3,78	6,78	1,08
3-CXP	2,10	3~/400/50	4,5	9,0	3~/400/50	3~/400/50	6,60	11,10	2,40
4-CXP	4,20	3~/400/50	6,0	12,0	3~/400/50	3~/400/50	10,20	16,20	4,50

E1/E2 - integrated electrical heater version.

W1/W2 - integrated water heater version.

### FILTER DATA

AmberAir Compact	Filter class	Dimensions, mm	Total filter surface area F7, m <sup>2</sup>	Total filter surface area M5, m <sup>2</sup>	Total filter surface area G4, m <sup>2</sup>	Initial pressure drop, Pa (F7/M5/G4)	Final pressure drop, Pa (F7/M5/G4)
1-CXP	F7, M5, G4	642x258x46	3,20	3,20	0,57	90/50/30	450/450/250
□-CXP	F7, M5, G4	894x279x46	2,38	2,38	0,86	90/50/30	450/450/250
3-CXP	F7, M5, G4	1000x279x46	2,67	2,67	0,96	90/50/30	450/450/250
4-CXP	F7, M5, G4	1113x379x46	4,03	4,03	1,46	90/50/30	450/450/250



# SMART SELECTION SOFTWARE

## VentMaster v5



### Key features:

- > Online price calculator (for registered users);
- > Saving of selected unit data on SLD server (for registered users);
- > Export of drawing in DXF file;
- > Export of technical specification to PDF;
- > Direct ordering through VentMaster (for registered users);
- > Automatic software updates;
- > Tested and certified by Eurovent.

### New VentMaster plug-in tool for Autodesk Revit offers new possibilities:

- > Revit and VentMaster connection: a designer can select, insert and update an AHU directly from Revit by launching VentMaster.
- > Additional technical data transfer to Revit.



VentMaster

Software is free of charge. Go to [www.salda.lt](http://www.salda.lt) to get your VentMaster.



Tested in independent Laboratory "SIVENTA", according EN ISO/IEC 17025.

### Performed tests:

- > Aerodynamic.
- > Thermal.
- > Acoustic.
- > Electrical performance.
- > Sound power level.
- > Sound energy level determination.

  
SLD server  
Ragainės g. 100  
LT-78109 Šiauliai, Lithuania

  
+370 41 54 04 15  
+370 41 54 04 17

  
office@salda.lt  
www.salda.lt

Distributor

