

		Date	2024-12-02	Control board for AHU MCB 219-2105		Power supply		= 219	
		Ed.	justasbalys					+	
		Appr.						Project Nr. 219-1924	
Modification	Date	Name	Original	Replacement of	Replaced by			Offer nr.	Page 1
									Page 1 / 17

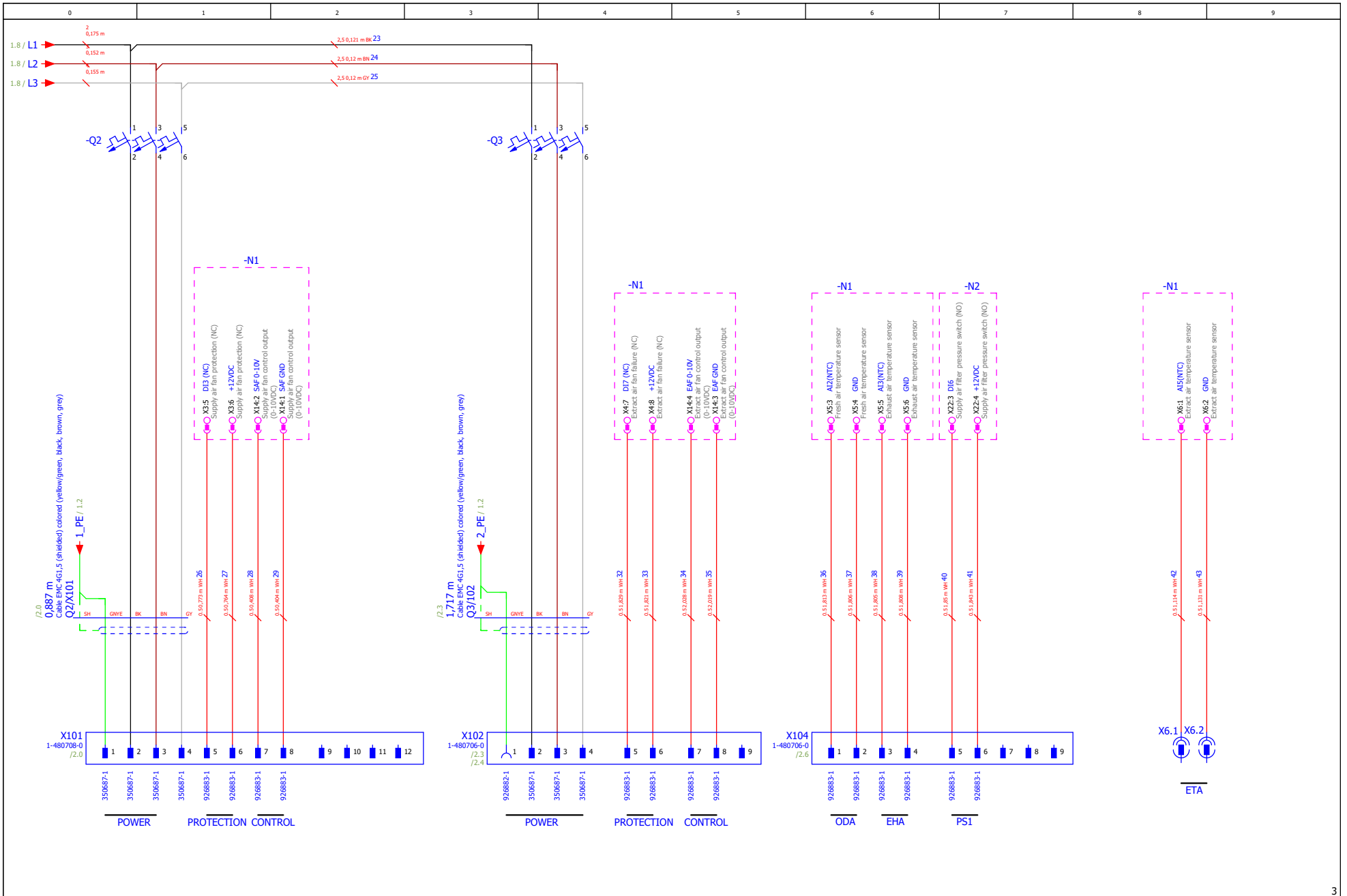

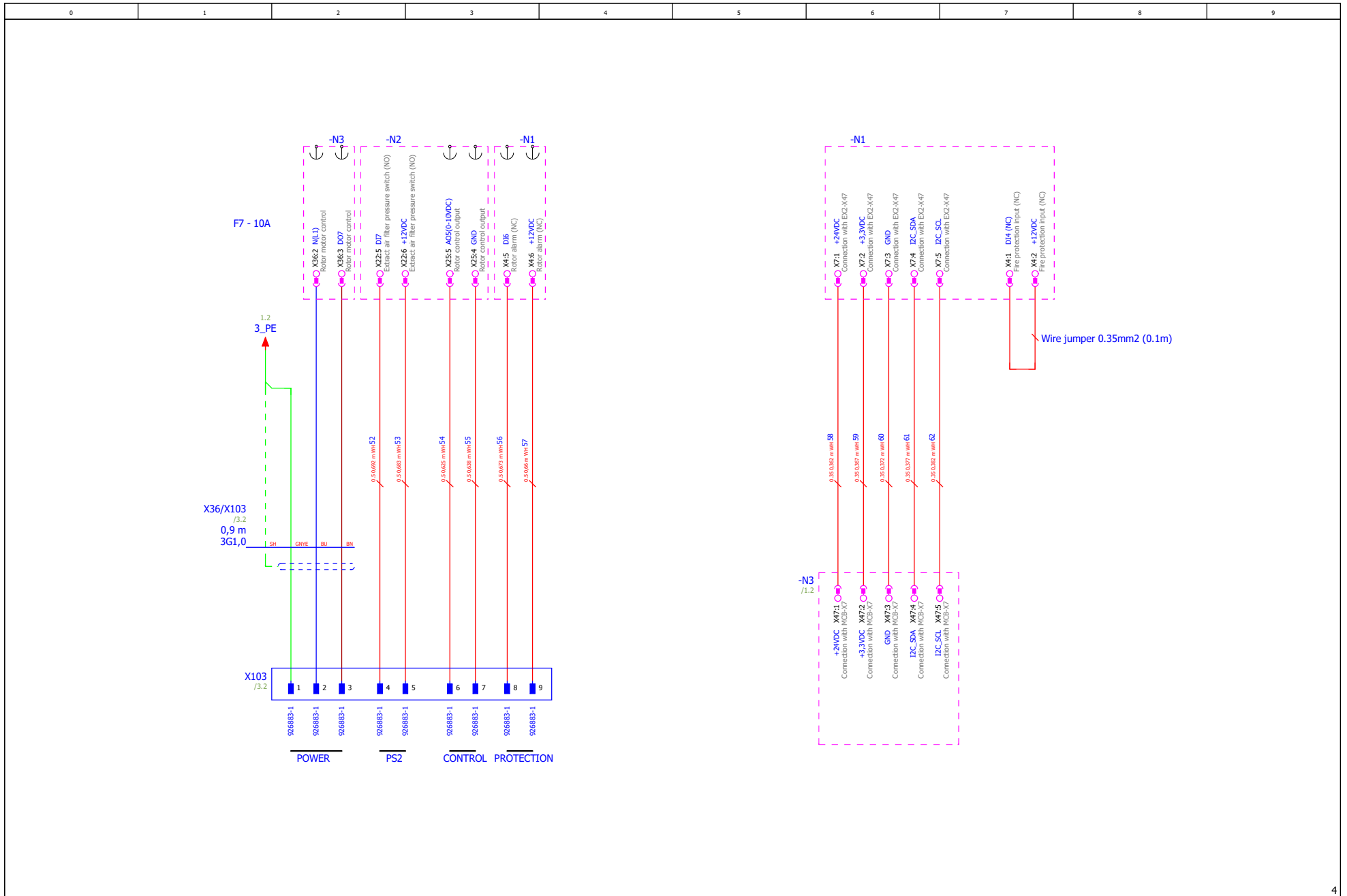

		Date	2024-12-02	Control board for AHU MCB 219-2105		Fans, Sensors, PS1			= 219
		Ed.	Justasbalys						+
		Appr.							
Modification	Date	Name	Original	Replacement of	Replaced by		Project Nr.	Offer nr.	Page
							219-1924		2
								Page	2 / 17



				Control board for AHU MCB 219-2105		Rotor, PS2, Communication		= 219	
				Ed. Justasbalys		SALDA		+	
				Appr.				Project Nr. 219-1924	
Modification	Date	Name	Original	Replacement of	Replaced by			Page 3	
								Page 3 / 17	

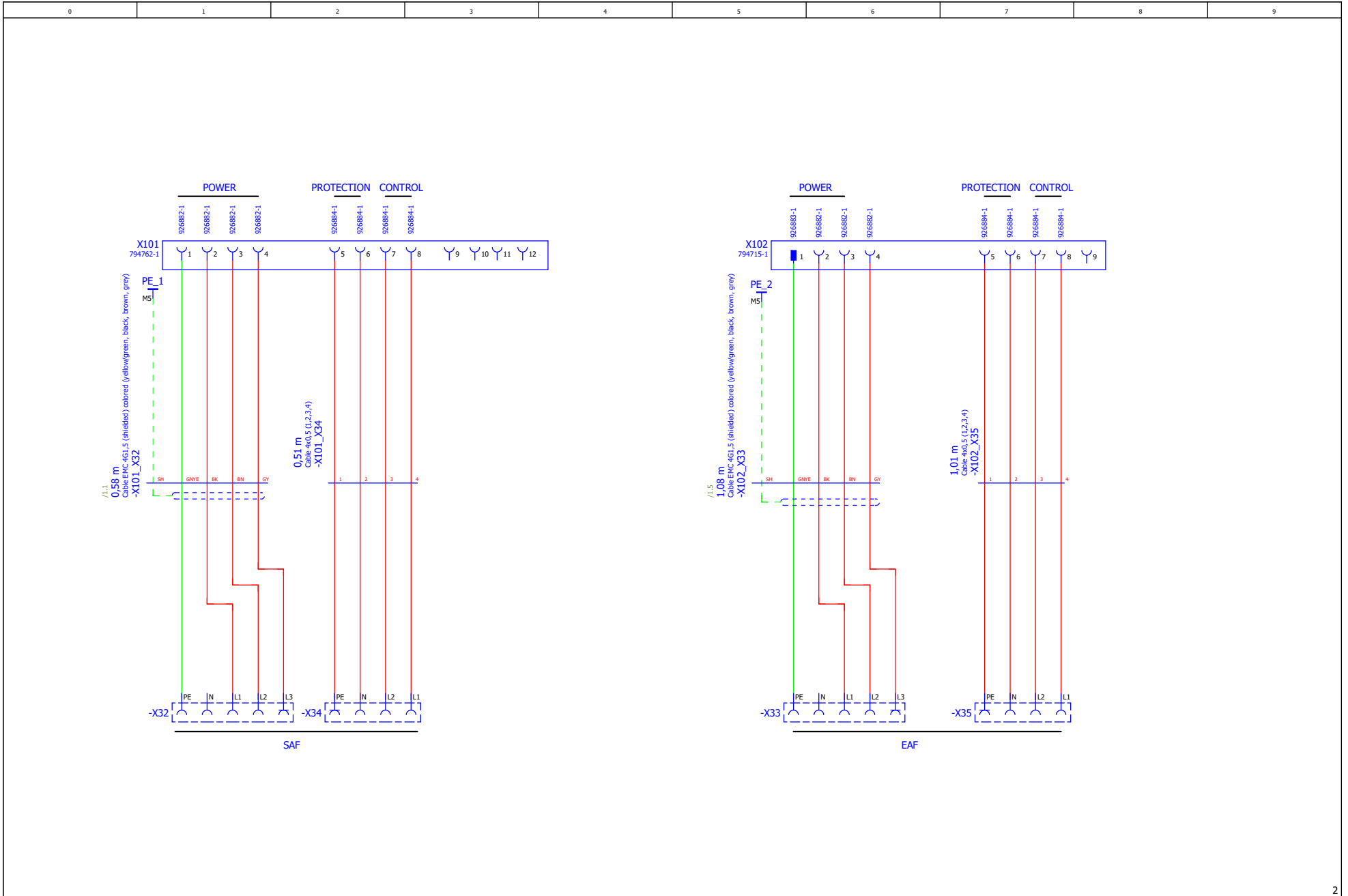

			Date	2024-12-02	SALDA	221.2907-PS	= 221.2907	
			Ed.	justasbalys			+	
			Appr.				Project Nr.	Offer nr.
Modification	Date	Name	Original		Replacement of	Replaced by		Page 1 / 8

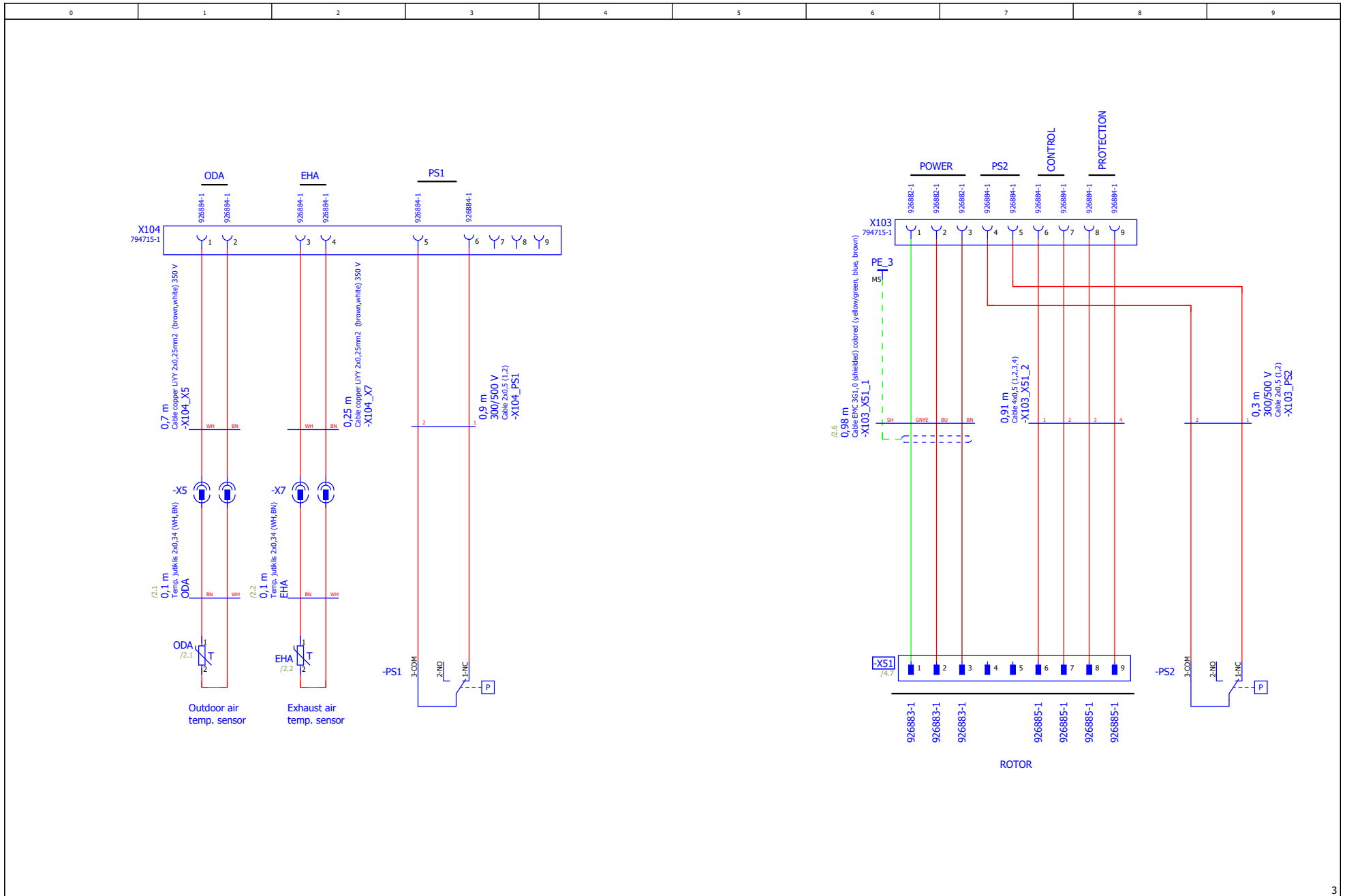

Modification	Date	Name	Original	Replacement of	Replaced by



221.2907-PS

= 221.2907	
+	
Project Nr.	Offer nr.
	Page 2
	Page 2 / 8

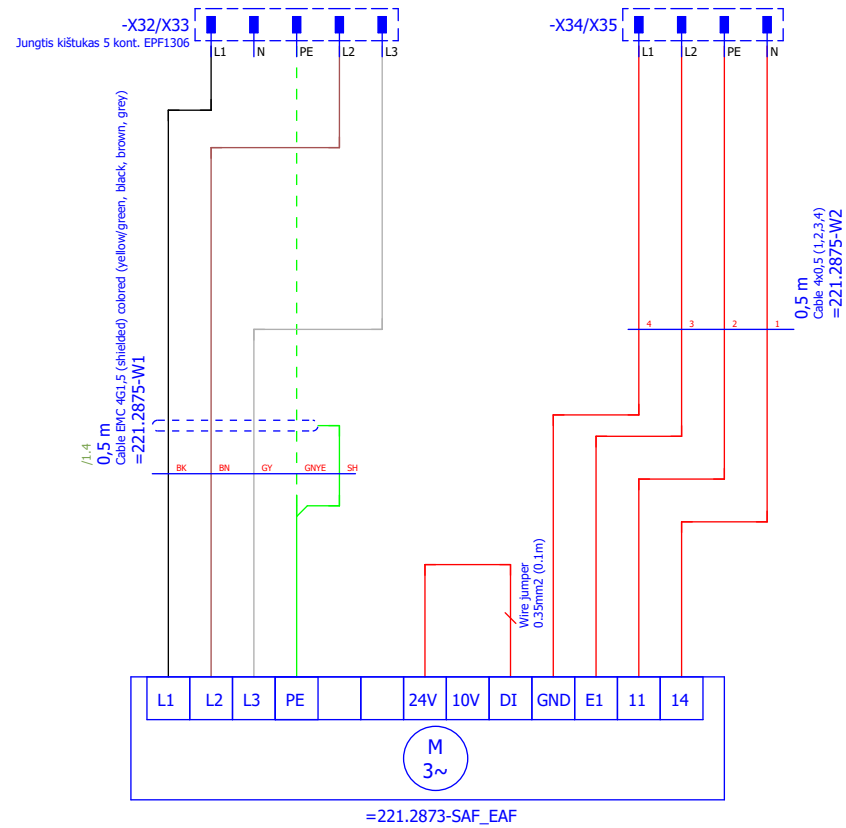

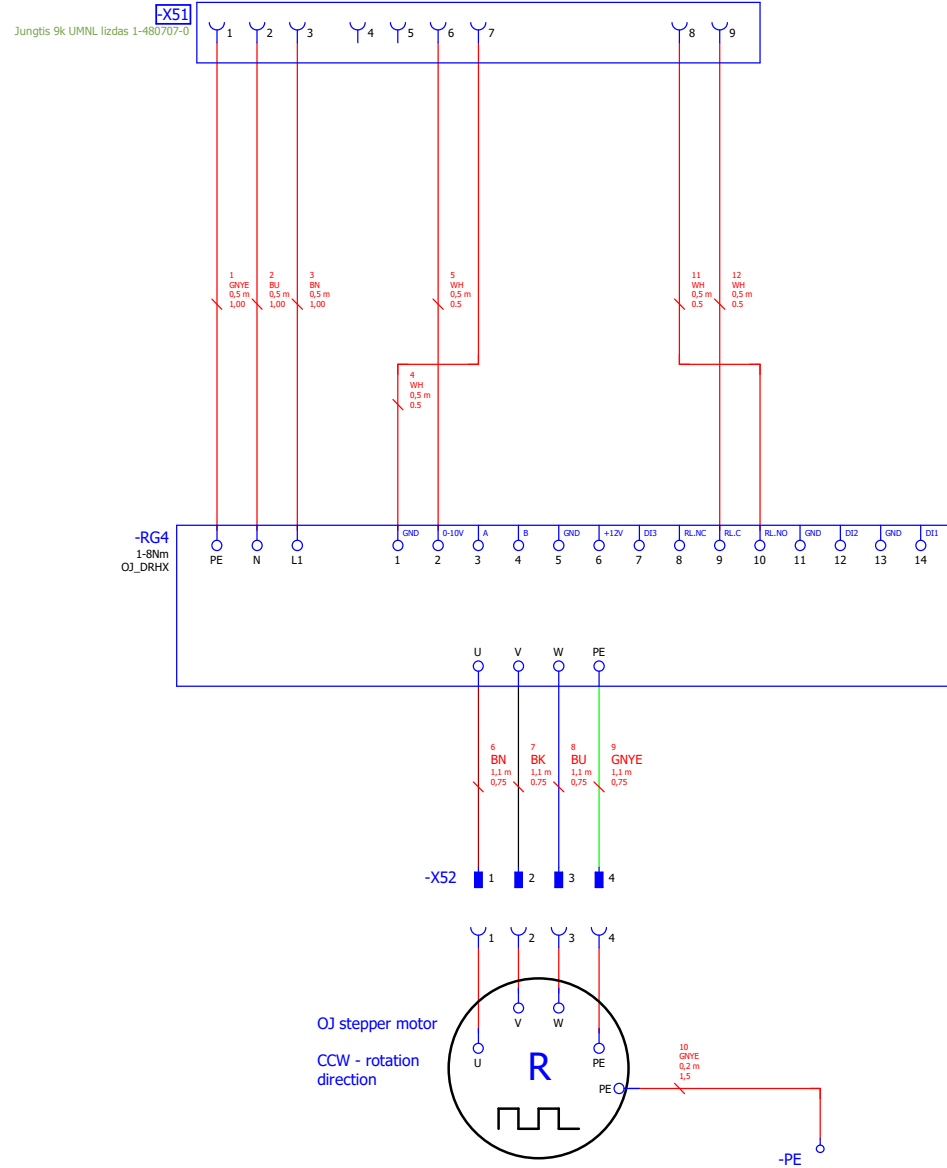

Date	2023-10-24				
Ed.	justasbalsys				
Appr.					
Modification	Date	Name	Original	Replacement of	Replaced by



221.2376-PS

Project Nr.	221.2376	Offer nr.		Page	1
				Page	1 / 2

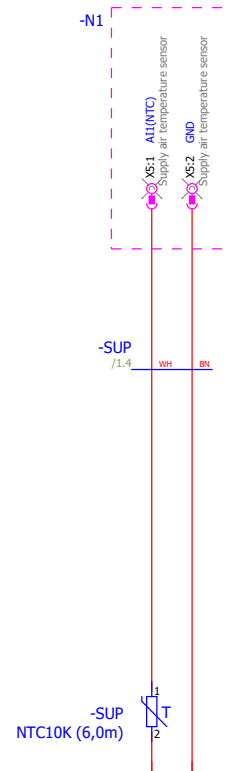

			Date	2023-01-20		
			Ed.	justasbalys		
			Appr.			
Modification	Date	Name	Original		Replacement of	Replaced by



SUP to MCB

		= SP150 (SUP connection to MCB)	
		+	
Project Nr.	Offer nr.	Page	1
		Page	1 / 1

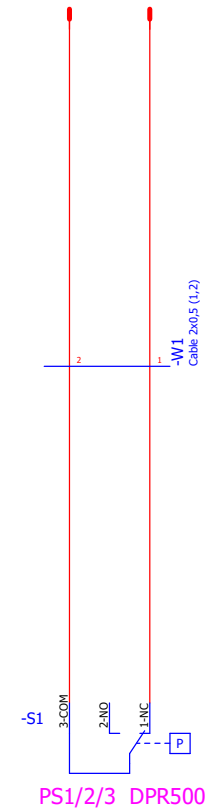
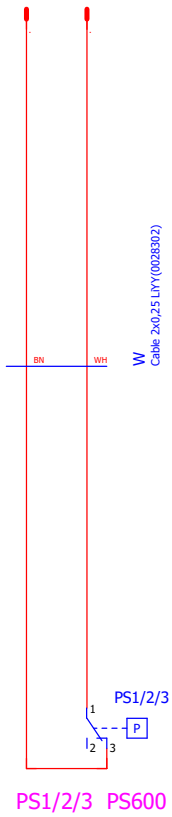

			Date	2023-12-05	SP158	
			Ed.	Vidas.Petruitis		
			Appr.			
Modification	Date	Name	Original		Replacement of	Replaced by



PS1/2/3 connection to harness (MCB)

		=
		+
Project Nr.	Offer nr.	Page SP158
		Page 1 / 1